

GOVERNMENT OF MEGHALAYA
OFFICE OF THE DIRECTOR GENERAL OF POLICE
MEGHALAYA :::: SHILLONG

SHORT NOTICE INVITING QUOTATIONS

Subject: Quotations for Procurement of CCTV Spare Parts / equipments for Shillong and Tura.

The Director General of Police, Meghalaya, Shillong invites Sealed Quotations from authorized manufacturers / suppliers / dealers for the supply of CCTV Spare Parts / equipments. The details of the equipments / spare parts required along with all relevant documents of the NIQ can be downloaded from the official website i.e. www.megpolice.gov.in. The Quotations will be received in the office of the undersigned up-to **1200 hrs** on **29-06-2020** and will be opened on the same date at **1600 hrs**. Quotations received after **1200 hrs** by hand or post will stand automatically rejected.

If the date of opening of Quotations happens to be a holiday, the next working day will be reckoned as the last date of receiving and opening of the same.

Sd/-

(Shri R. Chandranathan, IPS)

Director General of Police
Meghalaya, Shillong.

Memo No. PE.4/35/CCTV-TENDER/TECH/38

Dated Shillong the 15th June, 2020.

Copy forwarded to:-

1. The Addl. Director General of Police (L&O/TAP) / (SB/CID), Meghalaya, Shillong for favour of kind information.
2. The Inspector General of Police (HQ), Meghalaya, Shillong for favour of kind information.
3. The Dy. Inspector General of Police, (ER), Meghalaya, Shillong/ (WR), Meghalaya Tura for kind information.
4. The Superintendent of Police, East Khasi Hills, Shillong and /West Garo Hills, Tura.
5. The Special Superintendent of Police, (SB-I), Meghalaya, Shillong for information.
6. The Superintendent of Police (C), MPRO, Meghalaya Shillong for information.
7. The Director of Printing & Stationery Department, Shillong alongwith a copy of notice for publication in 2 (two) consecutive issue of the Meghalaya Gazette.
8. The Director of Information & Public Relation, Meghalaya, Shillong with a request to take necessary action from your end for publication in 2 (two) Newspapers (one impression) in English and in Khasi and submit the bill to this office for necessary action from this end.
9. The I/c Computer Wing with a soft copy containing the Quotation Notice along with all relevant documents for uploading the same in the Website of Meghalaya Police.

Asstt. Inspector General of Police (A),
Meghalaya, Shillong.

TERMS AND CONDITIONS:

1. Rates should be quoted F.O.R destination at Police Headquarters and should be inclusive of all charges like packing insurance and other incidental charges. Rates quoted should be clearly and neatly written in figures as well as in words. All correction/cancellation must be initialed, otherwise tender will stand rejected. **GST should be quoted separately on taxable items as deduction of Tax at Source will be effected accordingly on Firm's bills.**
2. Quotations should be addressed to the undersigned by designation and not by name, the Sealed envelope containing the quotation should be super scribed as **"CCTV Spare Parts / equipments for Shillong and Tura"** and be posted under registered cover or sent through messenger.
3. On items where rates quoted are as per ISI marked quality, I.S.I number/year along with copy of valid license should be furnished.
4. Attested copy of valid GST Registration Certificate and Tax Identification No. (TIN) and Pan Card of the quotationer should be enclosed **without which the Quotation shall be out rightly rejected.**
5. Attested copy of **Valid Trading License** from the concerned District Council Authority of Meghalaya in case of non-tribal firms/suppliers should be furnished along with the Quotation.
6. The Quotation should be affixed with a non refundable Court Fee Stamp of Rs. 200/-
7. An undertaking should be furnished that the supply/work will be done by the contractor/Quotationer himself/herself.
8. 1 (one) Nos. of attested passport size photograph is to be enclosed.
9. Up to date professional tax certificate is to be enclosed along with the quotation.
10. Up to date financial sound certificate from any Nationalized Banks is to be enclosed along with the quotation.
11. Catalogues/Brochures with detailed **Technical Specifications from the manufacturers for each item should be enclosed.**
12. If the item/equipment has been supplied earlier to CAPF or other State Police Forces, a copy of supply order with completion certificate should be enclosed along with the Quotation documents.
13. Those Quotationer's who are authorized Agent/Dealers of the Original Equipment Manufacturers (OEM) should submit a valid authorized dealership Certificate.

14. **The Dealership/Authorization Certificate should be submitted in original signed in ink with Seal. Computer generated Dealership/Authorization certificate will be out rightly rejected.**
15. **The risk on transport will have to be borne by the suppliers themselves** and in case any damages equipment is detected the same should be replaced immediately as per the approved sample.
16. The Director General of Police, Meghalaya **is not bound to accept the lowest quoted rates.**
17. The Director General of Police, Meghalaya reserves the right to **reject any of the tenders or cancel NIQ floated without assigning any reason thereof.**
18. If at the time of opening of Quotation, should there be any objection raised by the Quotationers/Representatives present as to the validity of any quotation, the objection will be duly recorded and will be put up to the Purchase Board for consideration. The decision of the Purchase Board on such objection will be final and binding.
19. The successful Quotationers will be intimated by a letter of acceptance by the Asstt. Inspector General of Police (A). Till then, no quotationer has any right to assume that his/her quotations have been accepted.
20. (A) In the event of contractor's/firm failing to perform his/her part of the contract to the satisfaction of the Department or disregard any terms or conditions of the Quotation Notice or the Contract Agreement, the contractor/firm/Supplier shall be liable to all or any of the following action:-
 - i) Forfeiture of Security Deposit in whole/part.
 - ii) Making good the loss caused to the Government through the inability, neglect or delaying to comply with the demand.
 - iii) Imposition of penalty (fine) in case of failure to make the supply within the stipulated time at the rate of 0.50% on the total amount of supply ordered for everyday not exceeding 2 weeks that he shall exceed his time either for the total supply or value of item(s) ordered for, and for liquidated damages.
 - iv) Cancellation of the contract without any prior notice of the contractor/supplier.
- (B) All losses sustained by the Government due to failure, omission or neglect of the contractor/firm/Dealer may be realized from his/her Security Deposit and outstanding dues or any other sums which may be due to him/her from the respective Controlling Officer.
21. If the contractor/firm/Dealer willfully neglects, fail to perform or observe any conditions of contract, or attempt to cheat or indulge in mal practice, the Director General of Police, Meghalaya may take necessary action to impose ban upon such contractors/firms for the future business with this Department.
22. Successful Quotationer will be required to furnish a Security Deposit and execute Contract Agreement to ensure fulfillment of the terms & conditions of the Contract which the successful Quotationer will have to enter into. The Security Deposit will be held by the Department free of interest and the deposit shall be subjected to forfeiture in case of non-fulfillment of any of the terms and conditions of the Contract.

23. Quotations not accompanied with all the required papers/documents or not fulfilling the terms & conditions will automatically stand rejected.
24. The Security Deposit will be deducted @ 10% of the value of the contract.
25. Once the rates offered in the quotations are accepted, no enhancement of rates will be accepted under any circumstances and the quotationer will be liable to supply at the rates approved and accepted by the Director General of Police, Meghalaya. Failure to make the supplies at the approved and accepted rates will entail cancellation of Contract Agreement and the Security Money will be forfeited to Government.
26. The selected Quotationer if possible to submit Samples of the equipments. Once the Samples is approved, **no changes in the brand name, shade pattern, quality or specification will be entertained** even on the plea of non-availability of raw materials or alternative offers of similar quality.
27. The stores supplied must be of the same specification, weight, brand and quality as per quoted specification.
28. (A):- Delivery shall have to be completed within **2 (two)** weeks from the date of receipt of supply orders. No extension of delivery period will be entertained beyond the stipulated period unless the approved supplier submits irrefutable grounds for extension and delivery. In case of the plea that the approved items are no longer manufactured for which the supply cannot be made, an authenticated certificate in original from the concerned manufacturer should be furnished. **No computer generated documents/certificate will be accepted.**
- (B):- The application for extension of time must be submitted to this office in time after receiving the firm order, and not later than the date fixed for completion of the supply. Applications for extension of time received after the stipulated time will not be considered.
29. **Payment will be made to the suppliers directly on completion of supplies and on correct receipt of goods by the respective consignee and based on the recommendation of the Line Committee.**
30. Documents/Vouchers/R.Rs bill etc., routed through Banks will not be accepted. Consignments will be dispatched by the Firm after payment of all freight charges at source. Freight to pay 'R.Rs' will not be accepted.
31. The Quotationer should quote only 1(one) offer per item, Quotationers quoting different options of the same item will be summarily rejected.

Sd/-

(Shri R. Chandranathan, IPS)
Director General of Police
Meghalaya, Shillong.

CERTIFICATE OF ACCEPTANCE OF TERMS AND CONDITIONS

(To be furnished along with the Quotation documents)

I/we have read and fully understood the terms and conditions as laid down in the NIQ vide Memo No. **PE.4/35/CCTV-TENDER/TECH/38** dated 15-06-2020 in respect of supply **CCTV Spare Parts / equipments for Shillong and Tura** to the office of the Director General of Police, Meghalaya, Shillong due to be opened on 29-06-2020.

I/We agree to abide by the same/

I/We have signed all the pages of the tender documents as laid down.

Signature and seal of the Tenderer
or his/her Authorized Signatory.

Dated _____

Name _____

Address _____

Phone No. _____

GOVERNMENT OF MEGHALAYA
OFFICE OF THE DIRECTOR GENERAL OF POLICE
MEGHALAYA :::: SHILLONG

QUOTATION NOTICE

Sealed QUOTATION for supply of **CCTV Spare Parts / equipments for Shillong and Tura** to Meghalaya Police will be received by the Asstt. Inspector General of Police, (A), Meghalaya, Shillong upto **29- 06 -2020 @ 1200 hrs** and will be opened on the same day at **1600 hrs**. For detailed information, please contact Asstt. Inspector General of Police (A), Meghalaya, Shillong during office hours in the O/o the Director General of Police, Meghalaya, Shillong-1. (All relevant documents of the NIQ can be downloaded from the official website i.e. **www.megpolice.gov.in**).

Asstt. Inspector General of Police (A),
Meghalaya, Shillong.

Annexure - A

List of CCTV Spare Parts / Equipments to be procured.

List of items listed

Sl. No.	ITEMS DESCRIPTION	MODEL
1	HIGH POWER NODE	ROCKET M5-UBIQUITI NETWORKS OR OTHER EQUIVALENT BRAND
2	MEDIUM POWER NODE	NANO BRIDGE M5 - UBIQUITI NETWORKS OR OTHER EQUIVALENT BRAND
3	LOW POWER NODE	NANO STATION LOCO M5-UBIQUITI NETWORKS OR OTHER EQUIVALENT BRAND
4	TOUGH SWITCH	TOUGH SWITCH POE PRO – UBIQUITI NETWORKS OR OTHER EQUIVALENT BRAND
5	D-LINK POE SWITCH	D-LINK DES-1210-08P-8 PORT POE SWITCH OR OTHER EQUIVALENT BRAND
6	INVERTER	EXIDE INVERTER
7	BULLET CAMERA	HIKVISION MODEL – DS-2CD4232FWD-IZ OR OTHER UPDATED MODEL COMPATIBLE TO THE SYSTEM
8	PTZ CAMERA	HIKVISION MODEL - DS-2DE7186-A OR OTHER UPDATED MODEL COMPATIBLE TO THE SYSTEM
9	PTZ ADAPTER	HIKVISION PTZ PSU 24VAC 2.5A OR OTHER UPDATED MODEL COMPATIBLE TO THE SYSTEM
10	CAT 6 WIRE 305 MTR	D-LINK CAT 6 CABLE
11	RJ 45 CONNECTOR	D-LINK RJ 45 CONNECTOR
12	CRIMPING TOOLS	D-LINK CRIMPING TOOL
13	NETWORK	UBIQUITI NETWORKS AF-5U OR OTHER EQUIVALENT BRAND
14	NETWORK	UBIQUITI NETWORKS AF-5X OR OTHER EQUIVALENT BRAND
15	NETWORK SWITCH	HUAWEI 24 PORTS NETWORK SWITCH OR OTHER EQUIVALENT BRAND
16	AIR FIBRE	48V PoE OF AIR FIBRE OR OTHER EQUIVALENT BRAND
17	NETWORK VIDEO RECORDER	HIKVISION DS-7716NI-E4 NETWORK VIDEO RECORDER OR OTHER UPDATED MODEL COMPATIBLE TO THE SYSTEM
18	CHEMICAL EARTHING	

Technical Specification of the above items are attached in **Annexures**.

CAT 6 ARMOURED CABLE (CP PLUSE) (CP-Plus (CP-EST-6TGA-305))



Cable Classification Cat-6 UTP

D-LINK RJ 45 CONNECTOR (D-Link)



Input pin Rating (AMP) 6 A

D LINK CRIMPING TOOL



65

Brand: D-Link

Min. Qty. Per: 1

1. Rs.1190.00

2. Rs 1064

Air Fibre 48V POE-

Ubiquiti Networks Poe-50-60W Poe External Injector



Weight: 6.77 oz.

Input Voltage: AC 120/230 V

Output Voltage: 50 V

US style power cord

Power LED

Remote reset capability

Earth grounding/ESD protection

Brand: Ubiquiti

UBIQUITI NETWORKS

TECHNICAL SPECS/DATASHEET



NanoBridge M5: World's First Cost-Effective 5GHz MIMO Bridging Solution

InnerFeed
antenna technology

airMAX
MIMO TDMA Protocol

2 MODELS

- NBM5-22 (22dBi Antenna)
- NBM5-25 (25dBi Antenna)

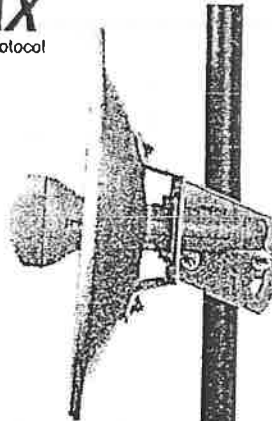
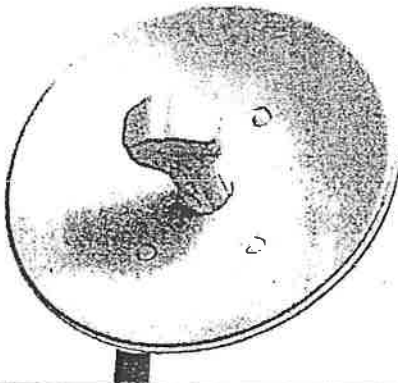

SYSTEM INFORMATION	
Processor Specs	Atheros MIPS 24KC, 400MHz
Memory Information	32MB SDRAM, 8MB Flash
Networking Interface	1 X 10/100 BASE-TX (Cat. 5, RJ-45) Ethernet Interface

REGULATORY / COMPLIANCE INFORMATION	
Wireless Approvals	FCC Part 15.247, IC RS210, CE
RoHS Compliance	YES

OPERATING FREQUENCY 5470MHz-5825MHz							
TX POWER SPECIFICATIONS			RX SPECIFICATIONS				
	DataRate	Avg. TX	Tolerance		DataRate	Sensitivity	Tolerance
AirMax / 11n	MCS0	23 dBm	+/-2dB	AirMax / 11n	MCS0	-96 dBm	+/-2dB
	MCS1	23 dBm	+/-2dB		MCS1	-95 dBm	+/-2dB
	MCS2	23 dBm	+/-2dB		MCS2	-92 dBm	+/-2dB
	MCS3	23 dBm	+/-2dB		MCS3	-90 dBm	+/-2dB
	MCS4	22 dBm	+/-2dB		MCS4	-86 dBm	+/-2dB
	MCS5	20 dBm	+/-2dB		MCS5	-83 dBm	+/-2dB
	MCS6	19 dBm	+/-2dB		MCS6	-77 dBm	+/-2dB
	MCS7	18 dBm	+/-2dB		MCS7	-74 dBm	+/-2dB
	MCS8	23 dBm	+/-2dB		MCS8	-95 dBm	+/-2dB
	MCS9	23 dBm	+/-2dB		MCS9	-93 dBm	+/-2dB
	MCS10	23 dBm	+/-2dB		MCS10	-90 dBm	+/-2dB
	MCS11	23 dBm	+/-2dB		MCS11	-87 dBm	+/-2dB
	MCS12	22 dBm	+/-2dB		MCS12	-84 dBm	+/-2dB
	MCS13	20 dBm	+/-2dB		MCS13	-79 dBm	+/-2dB
	MCS14	19 dBm	+/-2dB		MCS14	-78 dBm	+/-2dB
MCS15	18 dBm	+/-2dB	MCS15	-75 dBm	+/-2dB		

PHYSICAL / ELECTRICAL / ENVIRONMENTAL	
Dimensions	326mm diameter (22dBi) or 420mm diameter (25dBi)
Weight	135g (feed), 680g(bracket),750g(dish)
Enclosure Characteristics	Outdoor UV Rated Plastic
Mounting Kit	Pole Mounting Kit Included
Max Power Consumption	5.5 Watts
Power Supply	24V Carrier POE Adapter Included (POE-24)
Power Method	Passive Power over Ethernet (pairs 4,5+; 7,8 return)
Operating Temperature	-30C to 75C
Operating Humidity	5 to 95% Condensing
Shock and Vibration	ETSI300-019-1.4
Antenna Gain	22dBi or 25dBi

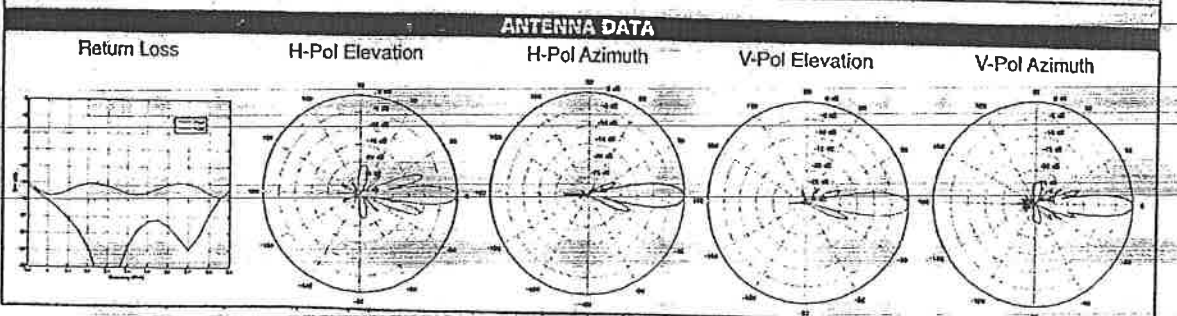

UBIQUITI NETWORKS

TECHNICAL SPECS/DATASHEET



ROCKET M5: 5GHz HI Power 2x2 MIMO AirMax TDMA BaseStation

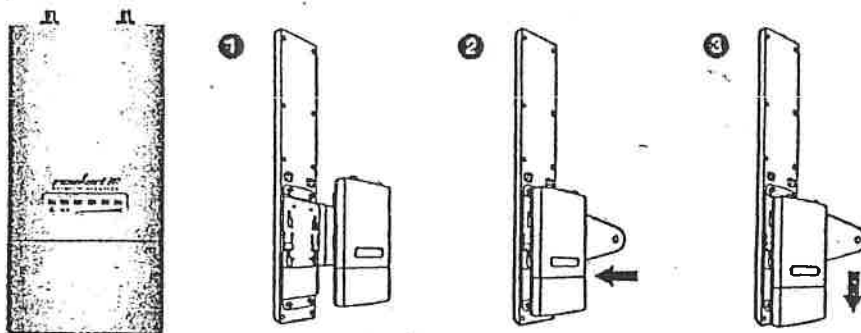

airMAX
MIMO TDMA Protocol

COMPATIBLE ANTENNAS

AirMax Sector 5G-17-90
AirMax Sector 5G-16-120
AirMax Sector 5G-20-90
AirMax Sector 5G-19-120
Rocket Dish 5G-30

SYSTEM INFORMATION

Processor Specs	Atheros MIPS 24KC, 400MHz
Memory Information	64MB SDRAM, 8MB Flash
Networking Interface	1 X 10/100 BASE-TX (Cat. 5, RJ-45) Ethernet Interface

REGULATORY / COMPLIANCE INFORMATION

Wireless Approvals	FCC Part 15.247, IC RS210, CE
RoHS Compliance	YES

OPERATING FREQUENCY: 5470MHz-5825MHz

5GHz TX POWER SPECIFICATIONS				5GHz RX SPECIFICATIONS			
	DataRate	Avg. TX	Tolerance		DataRate	Sensitivity	Tolerance
11a	6-24Mbps	27 dBm	+/-2dB	11a	6-24Mbps	-94 dBm min	+/-2dB
	36Mbps	25 dBm	+/-2dB		36Mbps	-80 dBm	+/-2dB
	48Mbps	23 dBm	+/-2dB		48Mbps	-77 dBm	+/-2dB
	54Mbps	22 dBm	+/-2dB		54Mbps	-75 dBm	+/-2dB
5GHz 11n	MCS0	27 dBm	+/-2dB	5GHz 11n	MCS0	-96 dBm	+/-2dB
	MCS1	27 dBm	+/-2dB		MCS1	-95 dBm	+/-2dB
	MCS2	27 dBm	+/-2dB		MCS2	-92 dBm	+/-2dB
	MCS3	27 dBm	+/-2dB		MCS3	-90 dBm	+/-2dB
	MCS4	26 dBm	+/-2dB		MCS4	-86 dBm	+/-2dB
	MCS5	24 dBm	+/-2dB		MCS5	-83 dBm	+/-2dB
	MCS6	22 dBm	+/-2dB		MCS6	-77 dBm	+/-2dB
	MCS7	21 dBm	+/-2dB		MCS7	-74 dBm	+/-2dB
	MCS8	27 dBm	+/-2dB		MCS8	-95 dBm	+/-2dB
	MCS9	27 dBm	+/-2dB		MCS9	-93 dBm	+/-2dB
	MCS10	27 dBm	+/-2dB		MCS10	-90 dBm	+/-2dB
	MCS11	27 dBm	+/-2dB		MCS11	-87 dBm	+/-2dB
	MCS12	26 dBm	+/-2dB		MCS12	-84 dBm	+/-2dB
	MCS13	24 dBm	+/-2dB		MCS13	-79 dBm	+/-2dB
	MCS14	22 dBm	+/-2dB		MCS14	-78 dBm	+/-2dB
MCS15	21 dBm	+/-2dB	MCS15	-75 dBm	+/-2dB		

PHYSICAL / ELECTRICAL / ENVIRONMENTAL

Enclosure Size	16cm length x 8cm width x 3cm height
Weight	0.5 kg
RF Connector	2x RPSMA (Waterproof)
Enclosure Characteristics	Outdoor UV-Stabilized Plastic
Mounting Kit	Pole Mounting Kit Included
Max Power Consumption	8 Watts
Power Supply	-24V, 1A-POE-Supply Included
Power Method	Passive Power over Ethernet (pairs 4,5+; 7,8 return)
Operating Temperature	-30C to 75C
Operating Humidity	5 to 95% Condensing
Shock and Vibration	ETSI300-019-1.4

802.11n / Airmax Support Only at this Time. 802.11a support expected with AirOS 5.1 Release by end of Year

UBIQUITI NETWORKS

TECHNICAL SPECS/DATASHEET



NanoStation Loco M5: Compact and cost-effective AirMax 5GHz CPE

airMAX
MIMO TDMA Protocol

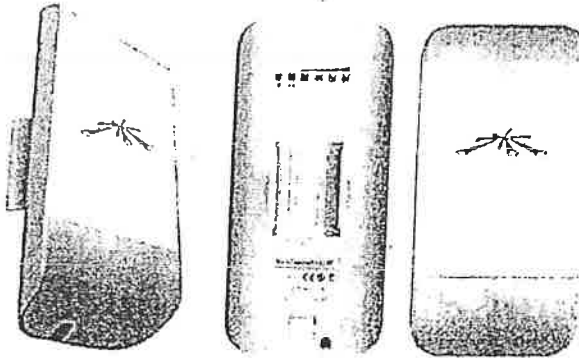

SYSTEM INFORMATION	
Processor Specs	Atheros MIPS 24KC, 400MHz
Memory Information	32MB SDRAM, 8MB Flash
Networking Interface	1 X 10/100 BASE-TX (Cat. 5, RJ-45) Ethernet Interface

REGULATORY / COMPLIANCE INFORMATION	
Wireless Approvals	FCC Part 15.247, IC RS210, CE
RoHS Compliance	YES

OPERATING FREQUENCY 5470MHz-5825MHz							
5GHz TX POWER SPECIFICATIONS				5GHz RX SPECIFICATIONS			
11a	DataRate	Avg. TX	Tolerance	11a	DataRate	Sensitivity	Tolerance
	1-24Mbps	23 dBm	+/-2dB		24Mbps	-83 dBm	+/-2dB
	36Mbps	21 dBm	+/-2dB		36Mbps	-80 dBm	+/-2dB
	48Mbps	19 dBm	+/-2dB		48Mbps	-77 dBm	+/-2dB
5GHz 11n / AirMax	54Mbps	18 dBm	+/-2dB	54Mbps	-75 dBm	+/-2dB	
	MCS0	23 dBm	+/-2dB	MCS0	-96 dBm	+/-2dB	
	MCS1	23 dBm	+/-2dB	MCS1	-95 dBm	+/-2dB	
	MCS2	23 dBm	+/-2dB	MCS2	-92 dBm	+/-2dB	
	MCS3	23 dBm	+/-2dB	MCS3	-90 dBm	+/-2dB	
	MCS4	22 dBm	+/-2dB	MCS4	-86 dBm	+/-2dB	
	MCS5	20 dBm	+/-2dB	MCS5	-83 dBm	+/-2dB	
	MCS6	18 dBm	+/-2dB	MCS6	-77 dBm	+/-2dB	
	MCS7	17 dBm	+/-2dB	MCS7	-74 dBm	+/-2dB	
	MCS8	23 dBm	+/-2dB	MCS8	-95 dBm	+/-2dB	
	MCS9	23 dBm	+/-2dB	MCS9	-93 dBm	+/-2dB	
	MCS10	23 dBm	+/-2dB	MCS10	-90 dBm	+/-2dB	
	MCS11	23 dBm	+/-2dB	MCS11	-87 dBm	+/-2dB	
	MCS12	22 dBm	+/-2dB	MCS12	-84 dBm	+/-2dB	
	MCS13	20 dBm	+/-2dB	MCS13	-79 dBm	+/-2dB	
MCS14	18 dBm	+/-2dB	MCS14	-78 dBm	+/-2dB		
MCS15	17 dBm	+/-2dB	MCS15	-75 dBm	+/-2dB		

PHYSICAL / ELECTRICAL / ENVIRONMENTAL	
Enclosure Size	163 x 31 x 80
Weight	0.18kg
Enclosure Characteristics	Outdoor UV Stabilized Plastic
Mounting Kit	Pole Mounting Kit Included
Max Power Consumption	5.5 Watts
Power Supply	24V, 0.5A surge protection Integrated POE adapter Included
Power Method	Passive Power over Ethernet (pairs 4,5+; 7,8 return)
Operating Temperature	-30C to +80C
Operating Humidity	5 to 95% Condensing
Shock and Vibration	ETSI300-019-1.4

INTEGRATED 2x2 MIMO ANTENNA			
Frequency Range	4.9-6.0 GHz	Max VSWR	1.4:1
Gain	13 dBi	H-pol Beamwidth	45 deg.
Polarization	Dual-Linear	V-pol Beamwidth	45 deg.
Cross-pol Isolation	20dB minimum	Elevation Beamwidth	45 deg.

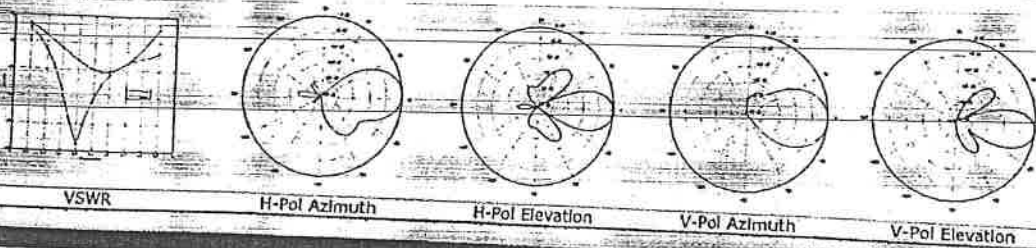

Specifications

Datasheet
TOUGHSwitch POE

8-Port TOUGHSwitch PoE PRO	
Dimensions	210 x 185 x 41 mm
Weight	1.24 kg
Power Input	110-120VAC / 210-230VAC
Max. Power Consumption	150 W
PoE Out Voltage Range	45-48VDC / 22-24VDC
Max. PoE Wattage Per Data Port	11.5 W (24 V), 23 W (48V)
ESD Rating	24 kV Air / 24 kV Contact
PoE Method	Passive
Button	Reset
USB Port	2.0 Type A (Reserved for Future Use)
Processor	MIPS 24K, 400 MHz
System Memory	64 MB
Code Storage	8 MB
Certifications	CE, FCC, IC
Operating Temperature	-25 to 55°C (-13 to 131° F)
Operating Humidity	90% Non-Condensing
PoE Configurable Per Port	
Management Port	N/A
Data Ports	Off/24V/48V
LEDs Per Port	
Management Port	Power/Link/Activity
Data Ports	PoE, Speed/Link/Activity
Networking Interfaces	
Management Port	(1) 10/100 Ethernet Port
Data Ports	(8) 10/100/1000 Ethernet Ports

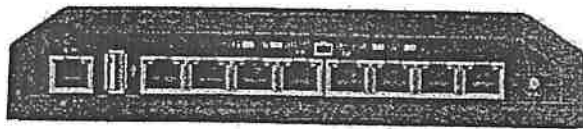

Front Panel

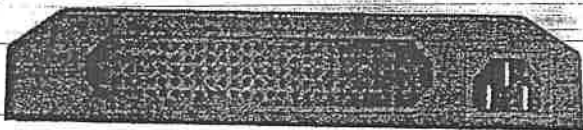

Back Panel

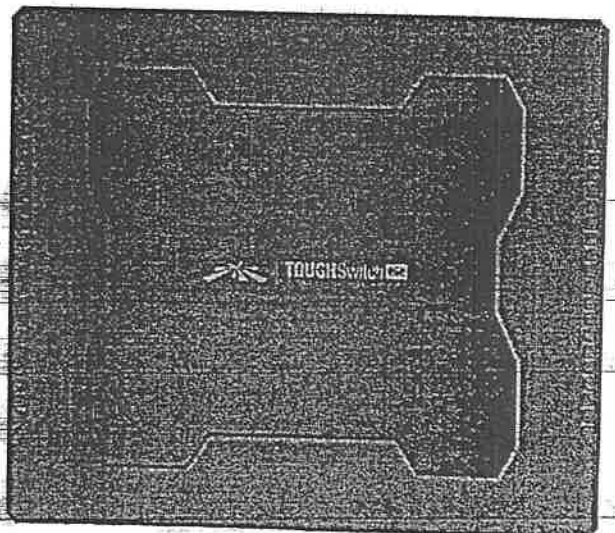

Top View

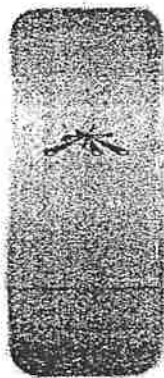

NANOSTATION LOCO M5

GENERAL

- Power Over Ethernet (PoE)

PoE

- Manufacturer

Ubiquiti Networks

POWER DEVICE

- Power Consumption Operational

5.5 Watt

CAMERA

- Installed Size

8 MB

INTERFACE PROVIDED

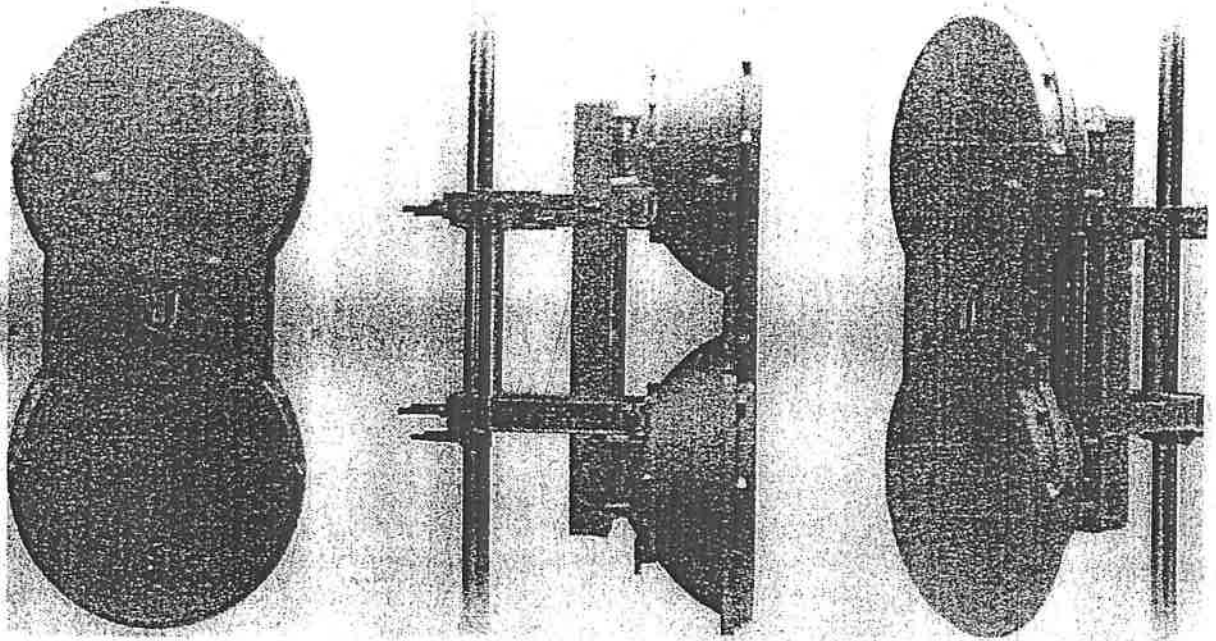

Ubiquiti Networks AF-5U Specs

General Specifications

LEDs	12 x Status LEDs: Data Port Link/Activity, Data Port Speed, Management Port, Link/Activity, Management Port Speed, GPS Synchronization, Master/Slave, Link Status, Modulation Mode 0.25x to 4x, 6x, 8x, Overload Remote and Local Displays (Calibrated Signal Strength)
Maximum Power Consumption	40 W
Power Supply	50 V, 1.2 A PoE Gigabit Ethernet adapter (included)
Power Method	Passive Power over Ethernet (42 to 58 VDC)
Wind Loading	863 N at 200 km/hr (194 lbf at 125 mph (200 km/hour
Wind Survivability	125 mph (200 km/hour (125 mph)
Mounting	Pole mount kit (included)
Operating Frequency	5725 - 5850 MHz 5725 - 5875 MHz 5725 - 6200 MHz

Interface

Data Port	1 x 10/100/1000 Ethernet port
-----------	-------------------------------

Configuration Port	1 x 10/100 Ethernet port
Auxiliary Port	1 x RJ-12, Alignment Tone port

System Specifications

Maximum Throughput	1.0+ Gb/s
Maximum Range	62+ miles (100+ km)
Packets per Second	>1 million
Encryption	128-bit AES
Forward Error Correction	164/205
Cyclic Prefix	1/16 fixed
Uplink/Downlink Ratio	50% fixed
Frame Synchronization	GPS
Frequency Selection	Dynamic: CE, CE, (FCC/IC Not Applicable)

Sensitivity Specifications

256QAM at 8x Spatial Stream, 1024 Mb/s FDD, 5 Mb/s TDD

At 10 MHz: -70 dBm

At 20 MHz: -67 dBm

At 40 MHz: -65 dBm

At 50 MHz: -64 dBm

64QAM at 6x Spatial Stream, 768 Mb/s FDD, 384 Mb/s TDD

At 10 MHz: -77 dBm

At 20 MHz: -74 dBm

At 40 MHz: -72 dBm

At 50 MHz: -71 dBm

16QAM MIMO at 4x Spatial Stream, 512 Mb/s FDD, 256 Mb/s TDD

At 10 MHz: -84 dBm

At 20 MHz: -81 dBm

At 40 MHz: -79 dBm

At 50 MHz: -78 dBm

QPSK MIMO at 2x Spatial Stream, 256 Mb/s FDD, 128 Mb/s TDD

At 10 MHz: -90 dBm

At 20 MHz: -87 dBm

At 40 MHz: -85 dBm

At 50 MHz: -84 dBm

1/2 Rate QPSK xRT at 1x Spatial Stream, 128 Mb/s FDD, 64 Mb/s TDD

At 10 MHz: -93 dBm

At 20 MHz: -90 dBm

At 40 MHz: -88 dBm

At 50 MHz: -87 dBm

1/4 QPSK xRT at 1/4x Spatial Stream, 32 Mb/s FDD, 16 Mb/s TDD

At 10 MHz: -95 dBm

At 20 MHz: -93 dBm

At 40 MHz: -92 dBm

Receive Sensitivity

At 50 MHz: -91 dBm

Radio Frequencies

GPS GPS clock synchronization

Transceiver Specification

EIRP ~50 dBm (Dependent on regulatory region and frequency band)

Frequency Accuracy ±2.5 ppm without GPS synchronization
±0.2 ppm with GPS synchronization

Channel Bandwidth 10/20/40/50 MHz

Modulation 256QAM MIMO
64QAM MIMO
16QAM MIMO
QPSK MIMO
1/2 Rate QPSK xRT
1/4 Rate QPSK xRT

Integrated Split Antenna

TX Gain 23 dBi

RX Gain 23 dBi

Beamwidth	6°
Front-to-Back Ratio	70 dB
Polarity	Dual-slant polarization
Cross Polar Isolation	>28 dB

Standards and Certifications

Certifications	CE, FCC, IC
----------------	-------------

Physical Characteristics

Operating Temperature	-40 to 131°F (-40 to 55°C)
Dimensions	25.5 x 16.8 x 11.9" (64.9 x 42.6 x 30.3 cm)
Weight	23.1 lb (10.5 kg) with mount

Packaging Info

Package Weight	57.0 lb
Box Dimensions (LxWxH)	40.8 x 22.5 x 20.0"

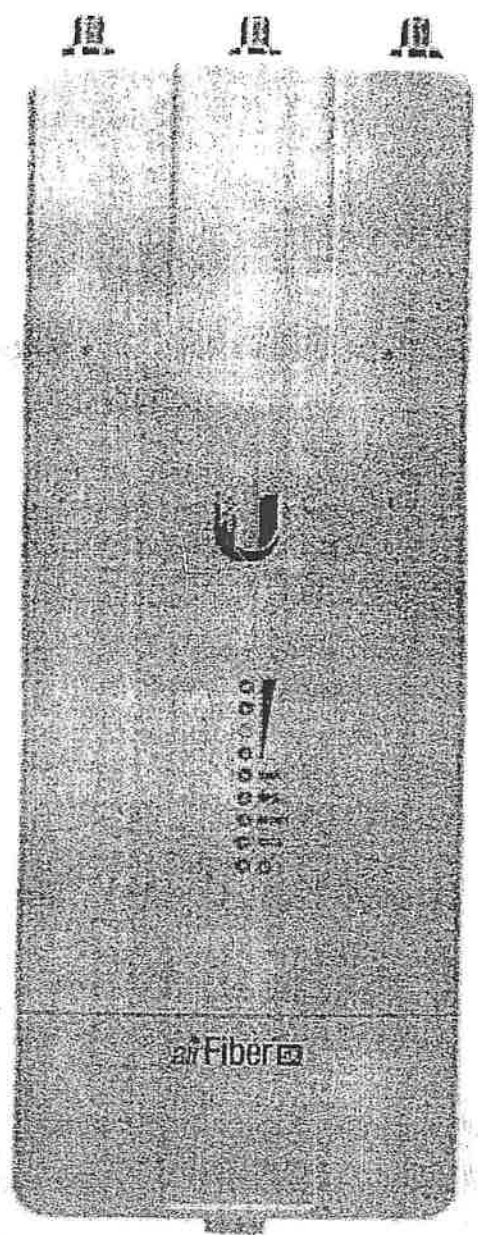

Ubiquiti Networks AirFiber 5X-US Specs

Maximum Range 656,168' / 200,000 m

Encryption 128-bit AES

Operating System airOS F

Wireless Modes Master/Slave

Radio Frequencies

Operating Frequency FCC 15.407: 5150 - 5350 MHz, 5470 - 5850 MHz
IC RSS-210: 5470 - 5600 MHz, 5650 - 5850 MHz
ETSI EN 301 893, EN 302 502: 5470 - 5875 MHz
Other Regions: 5150 - 5950 MHz

Power Max. Conducted TX Power: 26 dBm
(Dependent on regulatory region)

Frequency Accuracy ± 2.5 ppm without GPS synchronization
± 0.2 ppm with GPS synchronization

Channel Bandwidth 10/20/30/40/50 MHz selectable
Programmable uplink and downlink duty cycle

Environmental

Operating Temperature -40 to 131°F / -40 to 55°C

Dimensions & Weight

Dimensions 8.82 x 3.32 x 1.89" / 224.03 x 84.33 x 48.01 mm

Weight 0.77 lb / 0.35 kg

Packaging Info

Package Weight 2.45 lb

Box Dimensions (LxWxH) 10.5 x 4.4 x 4.4"

Specifications

RF Connectors	2 x RP-SMA Weatherproof (CH0, CH1) 1 x SMA Weatherproof (GPS)
GPS Antenna	External, Magnetic Base
Power Supply	24 V, 1 A PoE Gigabit Adapter (included)
Power Method	Passive Power over Ethernet





Mounting	airFiber X Mount (Rocket Mount compatible) GPS Pole Mount (included)
Certifications	DFS Certified FCC Part 15.407 CE EN 302501 EN 301 893 v1.7.1

Networking Interfaces

Data Port	1 x 10/100/1000 Ethernet Port
Management Port	1 x 10/100 Ethernet Port

System

Processor	INVICTUS IC
Maximum Throughput	500+ Mbps

Technical Specifications		DES-1210-08P	DES-1210-28	DES-1210-28P	DES-1210-52
					
General	Size	Desktop	19" rack mountable, 1U		
	Interface	8 10/100BASE-TX	24 10/100BASE-TX 2 1000BASE-T 2 Combo 1000BASE-T/SFP	24 10/100BASE-TXPoE 2 1000BASE-T 2 Combo 1000BASE-T/SFP	48 10/100BASE-TX 2 1000BASE-T 2 Combo 1000BASE-T/SFP
	Port Standards	IEEE 802.3 Ethernet IEEE 802.3u Fast Ethernet	IEEE 802.3 Ethernet IEEE 802.3u Fast Ethernet IEEE 802.3ab Gigabit Ethernet IEEE 802.3z Gigabit Ethernet (fiber)		
	Auto negotiation	Yes			
	IEEE 802.3x Flow Control	Yes			
	Auto MDI/MDIX	Yes			
	Performance	Switching Capacity	1.6 Gbps	12.8 Gbps	12.8 Gbps
64-Byte Packet Forwarding Rate		1.19 Gbps	9.5 Mpps	9.5 Mpps	13.1 Mpps
MAC Address Table Size		8K Entries			
Packet Buffer Memory		384 KB	512 KB	512 KB	1 MB
Flash Memory		16 MB			
Transmission Method		Store-and-forward			
PoE		PoE Standard	802.3af		802.3af and 802.3at
	PoE Capable Ports	Port 1-8 up to 15.4 watts per port		Port 1-4 up to 15.4 or 30 watts per port Port 5-24 up to 15.4 watts per port	
	PoE Power Budget	72 watts		193 watts	
LEDs	Power (Per Device)	Yes			
	Console (Per Device)	Yes			
	Link/Activity/Speed (Per Port)	Yes			
MTBF (Hours)	350,704 hours	419,467 hours	197,343 hours	289,012 hours	
Acoustics	0 dB	0 dB	53.9 dB	0 dB	
Heat Dissipation	305.03 BTU/hr	60.05 BTU per hour	866.65 BTU per hour	98.61 BTU per hour	
Power Input	100 to 240 VAC, 50 to 60 Hz Internal Universal Power Supply				
Max Power Consumption	89.4 Watts (PoE on) 9.7 Watts (PoE off)	17.6 watts	254 watts (PoE on), 26.4 watts (PoE off)	28.9 watts	
Dimensions (W x D x H)	190 x 120 x 38 mm	440 x 210 x 44 mm	440 x 250 x 44 mm	440 x 250 x 44 mm	
Fan Quality	Fanless	Fanless	3 Smart Fans ²	Fanless	
Operating Temperature	0 to 40° C				
Storage Temperature	-10 to 70° C				
Operating Humidity	5% to 95% non-condensing				
Emission (EMI)	FCC Class A, CE Class A, VCCI Class A, IC, C-Tick				
Safety	cUL, LVD				

²Default fan speed is low. Fan switches to high speed automatically at 33° C ambient temperature.

The heart of the network

D-Link[®]

PURE SINE WAVE



Exide GQP is a DSP based Pure Sine Wave Home UPS system with grid quality power output which guarantees 100% protection and long life to your electrical and electronic appliances.

24 MONTH WARRANTY

• ASIC Technology: Efficient battery charging enhances backup time, battery life and minimizes water topping

• State-of-the-art MOSFET based advanced PWM technology-greater efficiency

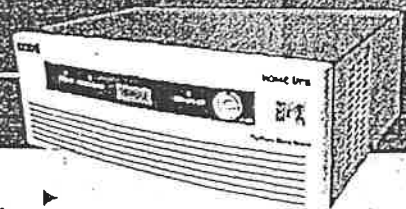

Features

- Battery Charging - 3 slots. Selectable Option: 9A/11A/13A manual battery charging selection sliding switch
- LCD Display: Shows status of battery voltage, AC Main Volt, Mains Cut and Load percentage on LCD
- Electrolyte Sensor: A red blinking LED indicates need for battery topping up (optional)
- Manual Bypass: Rocker Switch for manual operation to bypass mains input
- Output Socket: Additional output socket on the rear panel is an added input for emergency
- Change Over: Very fast change over time from Mains to UPS and vice versa
- Compact Surface Mount Technology: Reduces PCB size and enhances reliability
- Battery Charging, Charged, Power ON/OFF Indicators

Technical Specifications

Description	650VA	850VA	1050VA	1450VA
Output Voltage at No Load		220V ± 7V (AC)		220V ± 7V (AC)
Output Frequency		50Hz ± 1Hz		50Hz ± 1Hz
Output Waveform		Pure Sine Wave		Pure Sine Wave
Nominal Battery Voltage		12V (DC)		24V (DC)
Low Battery Cut-off		10.5V ± 0.2V		21.0V ± 0.2V

Charging Mode

Model	650VA	850VA	1050VA	1450VA
Charging Current three mode		Normal Charging 9.0A ± 1.0A		Normal Charging 9.0A ± 1.0A
		Enhanced Charging 11.0A ± 1.0A		Enhanced Charging 11.0A ± 1.0A
		High Charging 13.0A ± 1.0A		High Charging 13.0A ± 1.0A
Boost charging voltage		14.4V ± 0.2V		28.8V ± 0.2V
Trickle charging voltage		13.7V ± 0.2V		27.4V ± 0.2V
Charging technique		Auto battery charge level sense		Auto battery charge level sense
		Smart charger		Smart charger

UPS Mode

Changeover time inverter to mains		<=10msec*		<=10msec*
Changeover time mains to inverter		<=10msec*		<=10msec*
Input voltage range		180V to 260V ± 5V		180V to 260V ± 5V

*At mains low and high cut

DS-2CD4232FWD-I(Z)(S)(H)
3MP WDR IR Bullet Network Camera

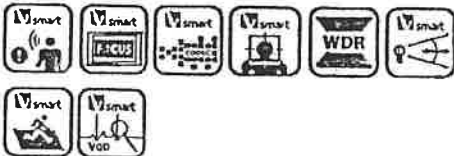
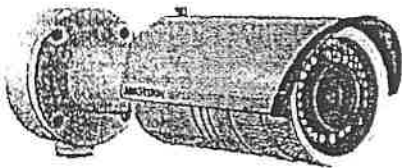

Key features

- Up to 2048 x 1536 high resolution
- Smart Codec
- 120dB WDR, 3D DNR
- Triple streams
- On-board storage, up to 128GB
- Smart Focus: Motorized VF lens (-Z)
- Smart VQD
- Smart Facial Detection
- Intrusion Detection
- Built-in heater
- Defog
- 8-32mm Motorized VF lens optional
- People Counting

Dimensions

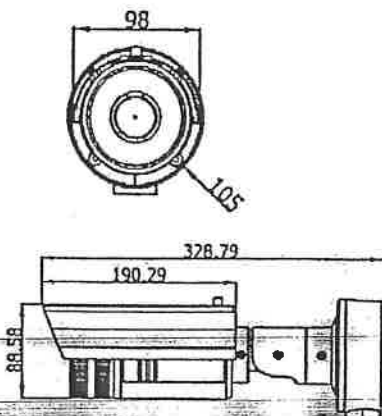

Available models

- DS-2CD4232FWD-I, DS-2CD4232FWD-IS
- DS-2CD4232FWD-IZ, DS-2CD4232FWD-IZS
- DS-2CD4232FWD-IZH, DS-2CD4232FWD-IZHS

- -Z: Motorized VF lens
- -S: 1-ch audio I/O, 1-ch alarm I/O
- -H: Smart Heater

DS-2CD4232FWD-I(Z)(S)(H)	
Camera	
Image sensor	1/3" progressive scan CMOS
Min. Illumination	0.1 lux@F1.2, AGC on, 0.14 lux@F1.4, AGC on, 0 lux with IR
Shutter time	1s - 1/100,000s
Slow shutter	Yes
Lens	2.8 - 12mm @F1.4, angle of view: 91.2° - 28.3° (-Z & non-Z model) (-Z: motorized VF lens) * 8-20mm @F1.6 lens (optional), angle of view: 33.2° - 13.8° (Option for -Z model) * 8-32mm @F1.4 lens, angle of view: 26° - 8.54° (option for -Z model)
Lens mount	Ø14
Auto iris	DC drive
Day & night	ICR (Auto/Schedule/Alarm Trigger)
Digital noise reduction	3D DNR
Wide dynamic range	120dB WDR
Compression standard	
Video compression	H.264 / MPEG4 / MJPEG
H.264 codec profile	Baseline profile / main profile / high profile
Video bit rate	32 Kbps - 16 Mbps
Audio compression	G.711 / G.722.1 / G.726 / MP2L2 *only for -S model
Audio bit rate	64Kbps(G.711) / 16Kbps(G.722.1) / 16Kbps(G.726) / 32-128Kbps(MP2L2)
Image	
Max. resolution	2048 x 1536
Frame rate	50 Hz: 20fps (2048 x 1536), 25fps (1920 x 1080), 25fps (1280 x 720) 60 Hz: 20fps (2048 x 1536), 30fps (1920 x 1080), 30fps (1280 x 720)
3rd stream	Independent setting, up to: 50Hz: 20fps (2048 x 1536), 60Hz: 20fps (2048 x 1536)
Image settings	Rotate mode, saturation, brightness, contrast, grayscale adjustable through client software or web browser
BLC	Yes, zone configurable
Defog	Yes
EIS	Yes
Picture overlay	128 x 128, BMP 24bit, zone configurable
ROI	Support
Network	
Network storage	NAS (Support NFS, SMB/CIFS)
Alarm trigger	Intrusion detection, Defocus detection, Motion detection, Face detection, line crossing detection, Dynamic analysis, Tampering alarm, Network disconnect, IP address conflict, Storage exception
Protocols	TCP/IP, ICMP, HTTP, HTTPS, FTP, DHCP, DNS, DDNS, RTP, RTSP, RTCP, PPPoE, NTP, UPnP, SMTP, SNMP, IGMP, 802.1X, QoS, IPv6, Bonjour
Security	User authentication, watermark, IP address filtering, anonymous access, reset
System compatibility	ONVIF, PSIA, CGI, ISAPI
Interface	
Communication interface	1 RJ45 10M / 100M ethernet port
On-board storage	Built-in Micro SD/SDHC/SDXC slot, up to 128GB
Reset button	Yes
General	
Operating conditions	-30°C ~ 60°C (-22°F ~ 140°F), humidity 95% or less (non-condensing) +H: -40°C ~ 60°C (-40°F ~ 140°F), with smart heater on
Power supply	12VDC ± 10%, PoE (802.3af)
Power consumption	Max. 11.5W -Z/-H: Max. 12.5W
IR range	Up to 30m Up to 80m IR with 8-20mm/8-32mm VF lens
Ingress protection	IP66
Dimensions	98 x 105 x 328.8 mm
Weight	1700 g (3.75 lbs)

HIKVISION

DS-2DE7186/7184 series 2MP Network IR PTZ Dome Camera



Key features

- 1/2.8" Progressive Scan CMOS
- 1080P Full HD resolution
- 30X / 20X optical zoom, 16X digital zoom
- Up to 100m IR distance
- True Day/Night, 3D DNR, Digital WDR
- 3D intelligent positioning
- 24VAC / High-PoE power supply

Dimensions

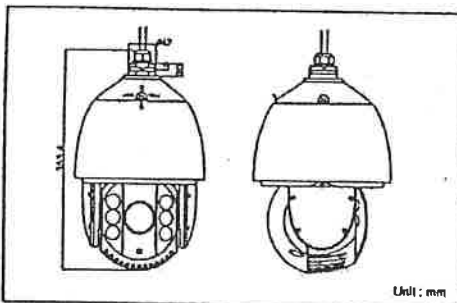

Accessories

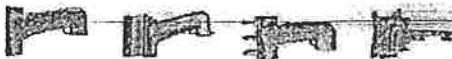

DS-1601ZJ

DS-1601ZJ-corer

DS-1601ZJ-pole

DS-1634ZJ

Available models

DS-2DE7186-A: 24VAC, outdoor
DS-2DE7186-AE: High-PoE & 24VAC, outdoor

DS-2DE7184-A: 24VAC, outdoor
DS-2DE7184-AE: High-PoE & 24VAC, outdoor

	DS-2DE7186-A DS-2DE7186-AE	DS-2DE7184-A DS-2DE7184-AE
Camera		
Image sensor	1/2.8" Progressive Scan CMOS	
Effective pixel	2230K pixels	
Min. illumination	Color: 0.05lux (F1.6, AGC ON), 0 lux with IR; B/W: 0.01lux (F1.6, AGC ON), 0 lux with IR	
White balance	Auto / Manual / ATW / Indoor / Outdoor / Daylight lamp / Sodium lamp	
AGC	Auto / Manual	
S / N ratio	≥ 52dB	
Digital noise Reduction	3D DNR	
Backlight compensation	HLC/BLC	
Wide dynamic range	Digital WDR	
Shutter speed	1 - 1/10,000s	
Day & Night	IR Cut Filter	
Digital zoom	16X	
Privacy masking	2 privacy masks programmable	
Focus mode	Auto / Semiautomatic / Manual	
Lens		
Focal length	4.3 - 129mm, 30x	4.7 - 94mm, 20x
Zoom speed	Approx 3s(Optical Wide-Tele)	Approx 3s(Optical Wide-Tele)
Angle of view	65.1 - 2.34 degree (Wide-Tele)	58.3 - 3.2 degree (Wide-Tele)
Min. working distance	10 - 1500mm(Wide-Tele)	10 - 1000mm(Wide-Tele)
Aperture range	F1.6 - F5.0	F1.6 - F3.5
Pan and Tilt		
Pan / Tilt range	Pan: 360° endless; Tilt: -15° - 90° (Auto Flip)	
Pan / Tilt speed	Pan Manual Speed: 0.1° - 160°/s, Pan Preset Speed: 240°/s Tilt Manual Speed: 0.1° - 120°/s, Tilt Preset Speed: 200°/s	
Proportional zoom	Rotation speed can be adjusted automatically according to zoom multiples	
Number of preset	256	
Park action	Pattern/Pan scan/Tilt scan/Frame scan/Panorama scan/Random scan	
Patrol	8 patrols, up to 32 presets per patrol	
Power-off memory	Support	
PTZ position display	Support	
Preset freezing	Support	
Scheduled task	Preset / Patrol / Pattern / Pan scan / Tilt scan / Random scan / Frame scan / Panorama scan/Dome reboot/Self-test action/Alarm output	
Infrared		
IR distance	Up to 100m	
IR intensity	Automatically adjusted, depending on the zoom ratio	
Local Video/Audio		
Audio input	1 Mic in/Line in interface, Line input: 2 - 2.4V(p-p); output impedance: 1KΩ, ±10%	
Audio output	1 Audio output interface, Line level, Impedance: 600Ω	
Network		
Ethernet	10Base-T / 100Base-TX, RJ45 connector	
Max. image resolution	1920x1080	
Frame rate	50Hz: 25 fps (1920x1080), 25 fps (1280x960), 25 fps (1280x720) 60Hz: 30 fps (1920x1080), 30 fps (1280x960), 30 fps (1280x720)	
Image compression	H.264/MJPEG	
Audio compression	G.711u / G.711a / G.726 / MP2L2	
Protocols	IPv4/IPv6, HTTP, HTTPS, 802.1x, Qos, FTP, SMTP, UPnP, SNMP, DNS, DDNS, NTP, RTSP, RTP, TCP, UDP, IGMP, ICMP, DHCP, PPPoE	
Simultaneous live view	Up to 6	
Streams	Dual streams	
Mini SD memory card	Micro SD slot, up to 32GB	
User/Host level	Up to 32 users, 3 Levels: Administrator, Operator, User	
Security measures	User authentication (ID and PW), Host authentication (MAC address), IP address filtering	
Integration		
Application programming	Open-ended API, support Onvif, PSIA and CGI	
Web browser	IE 7+, Chrome 18+, Firefox 5.0+, Safari 5.0+	
General		
Power	-A: 24 VAC, max. 30W -AE: High-PoE & 24 VAC, max. 30W	
Working temperature	-30 °C - 65°C (-22°F - 149°F)	
Humidity	80% or less	
Protection level	IP66, TVS 4,000V lightning protection, surge protection and voltage transient protection	
Dimensions	Φ220x353.4mm (Φ8.66"x13.91") (Outdoor)	
Weight	Approx. 5.5kg(12.13lbs)	
Mount option	Long-arm wall mount: DS-1601ZJ; Pole Mount: DS-1601ZJ-pole; Corner mount: DS-1601ZJ-corer; Power box mount: DS-1634ZJ	

HIKVISION

DS-2DE7186/7184 series 2MP Network IR PTZ Dome Camera



Key features

- 1/2.8" Progressive Scan CMOS
- 1080P Full HD resolution
- 30X / 20X optical zoom, 16X digital zoom
- Up to 100m IR distance
- True Day/Night, 3D DNR, Digital WDR
- 3D intelligent positioning
- 24VAC / High-PoE power supply

Dimensions

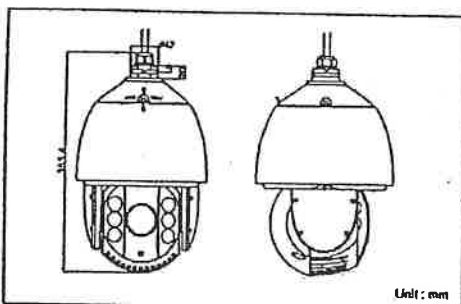

Accessories

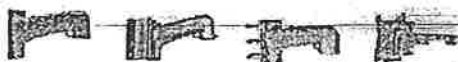

DS-1601ZJ

DS-1601ZJ-corner

DS-1601ZJ-pole

DS-1634ZJ

Available models

DS-2DE7186-A: 24VAC, outdoor
DS-2DE7186-AE: High-PoE & 24VAC, outdoor

DS-2DE7184-A: 24VAC, outdoor
DS-2DE7184-AE: High-PoE & 24VAC, outdoor

	DS-2DE7186-A DS-2DE7186-AE	DS-2DE7184-A DS-2DE7184-AE
Camera		
Image sensor	1/2.8" Progressive Scan CMOS	
Effective pixel	2230K pixels	
Min. illumination	Color: 0.05lux (F1.6, AGC ON), 0 lux with IR; B/W: 0.01lux (F1.6, AGC ON), 0 lux with IR	
White balance	Auto / Manual /ATW/Indoor/Outdoor/Daylight lamp/Sodium lamp	
AGC	Auto / Manual	
S / N ratio	≥ 52dB	≥ 50dB
Digital noise Reduction	3D DNR	
Backlight compensation	HLC/BLC	
Wide dynamic range	Digital WDR	
Shutter speed	1 - 1/10,000s	
Day & Night	IR Cut Filter	
Digital zoom	16X	
Privacy masking	2 privacy masks programmable	
Focus mode	Auto / Semiautomatic / Manual	
Lens		
Focal length	4.3 - 129mm, 30x	4.7 - 94mm, 20x
Zoom speed	Approx 3s(Optical Wide-Tele)	Approx 3s(Optical Wide-Tele)
Angle of view	65.1 - 2.34 degree (Wide-Tele)	58.3 - 3.2 degree (Wide-Tele)
Min. working distance	10 - 1500mm(Wide-Tele)	10 - 1000mm(Wide-Tele)
Aperture range	F1.6 - F5.0	F1.6 - F3.5
Pan and Tilt		
Pan / Tilt range	Pan: 360° endless; Tilt: -15° - 90° (Auto Flip)	
Pan / Tilt speed	Pan Manual Speed: 0.1° - 160°/s, Pan Preset Speed: 240°/s Tilt Manual Speed: 0.1° - 120°/s, Tilt Preset Speed: 200°/s	
Proportional zoom	Rotation speed can be adjusted automatically according to zoom multiples	
Number of preset	256	
Park action	Pattern/Pan scan/Tilt scan/Frame scan/Panorama scan/Random scan	
Patrol	8 patrols, up to 32 presets per patrol	
Power-off memory	Support	
PTZ position display	Support	
Preset freezing	Support	
Scheduled task	Preset / Patrol / Pattern / Pan scan / Tilt scan / Random scan / Frame scan / Panorama scan/Dome reboot/Self-test action/Alarm output	
Infrared		
IR distance	Up to 100m	
IR intensity	Automatically adjusted, depending on the zoom ratio	
Local Video/Audio		
Audio input	1 Mic in/Line In Interface, Line input: 2 - 2.4V(p-p), output impedance: 1KΩ, ±10%	
Audio output	1 Audio output Interface, Line level, Impedance: 600Ω	
Network		
Ethernet	10Base-T / 100Base-TX, RJ45 connector	
Max. image resolution	1920×1080	
Frame rate	50Hz: 25 fps (1920×1080), 25 fps (1280×960), 25 fps (1280×720) 60Hz: 30 fps (1920×1080), 30 fps (1280×960), 30 fps (1280×720)	
Image compression	H.264A/MJPEG	
Audio compression	G.711u / G.711a / G.726 / MP2L2	
Protocols	IPv4/IPv6, HTTP, HTTPS, 802.1x, Qos, FTP, SMTP, UPnP, SNMP, DNS, DDNS, NTP, RTSP, RTP, TCP, UDP, IGMP, ICMP, DHCP, PPPoE	
Simultaneous live view	Up to 6	
Streams	Dual streams	
Mini SD memory card	Micro SD slot, up to 32GB	
User/Host level	Up to 32 users, 3 Levels: Administrator, Operator, User	
Security measures	User authentication (ID and PW), Host authentication (MAC address), IP address filtering	
Integration		
Application programming	Open-ended API, support Onvif, PSIA and CGI	
Web browser	IE 7+, Chrome 18+, Firefox 5.0+, Safari 5.0+	
General		
Power	-A: 24 VAC, max. 30W -AE: High-PoE & 24 VAC, max. 30W	
Working temperature	-30 °C - 65°C (-22°F - 149°F)	
Humidity	80% or less	
Protection level	IP66, TVS 4,000V lightning protection, surge protection and voltage transient protection	
Dimensions	∅220×353.4mm (∅8.66"×13.91") (Outdoor)	
Weight	Approx. 5.5kg(12.13lbs)	
Mount option	Long-arm wall mount: DS-1601ZJ; Corner mount: DS-1601ZJ-corner; Pole Mount: DS-1601ZJ-pole; Power box mount: DS-1634ZJ	

DS-2DE7186/7184 series
2MP Network IR PTZ Dome Camera



Key features

- 1/2.8" Progressive Scan CMOS
- 1080P Full HD resolution
- 30X / 20X optical zoom, 16X digital zoom
- Up to 100m IR distance
- True Day/Night, 3D DNR, Digital WDR
- 3D intelligent positioning
- 24VAC / High-PoE power supply

Dimensions

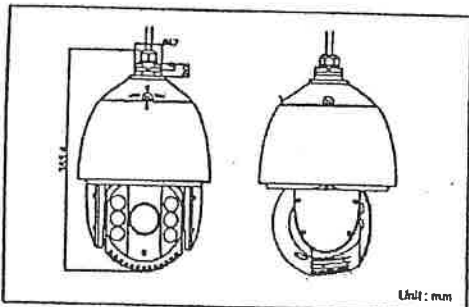

Accessories

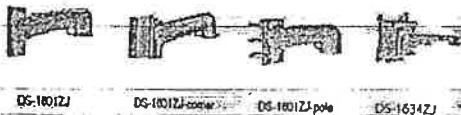

Available models

- DS-2DE7186-A: 24VAC, outdoor
- DS-2DE7186-AE: High-PoE & 24VAC, outdoor
- DS-2DE7184-A: 24VAC, outdoor
- DS-2DE7184-AE: High-PoE & 24VAC, outdoor

	DS-2DE7186-A DS-2DE7186-AE	DS-2DE7184-A DS-2DE7184-AE
Camera		
Image sensor	1/2.8" Progressive Scan CMOS	
Effective pixel	2230K pixels	
Min. illumination	Color: 0.05lux (F1.6, AGC ON), 0 lux with IR ; BW: 0.01lux (F1.6, AGC ON), 0 lux with IR	
White balance	Auto / Manual / ATW/Indoor/Outdoor/Daylight lamp/Sodium lamp	
AGC	Auto / Manual	
S / N ratio	≥ 52dB	≥ 50dB
Digital noise Reduction	3D DNR	
Backlight compensation	HLC/BLC	
Wide dynamic range	Digital WDR	
Shutter speed	1 - 1/10,000s	
Day & Night	IR Cut Filter	
Digital zoom	16X	
Privacy masking	2 privacy masks programmable	
Focus mode	Auto / Semiautomatic / Manual	
Lens		
Focal length	4.3 - 129mm, 30x	4.7 - 94mm, 20x
Zoom speed	Approx 3s(Optical Wide-Tele)	Approx 3s(Optical Wide-Tele)
Angle of view	65.1 - 2.34 degree (Wide-Tele)	58.3 - 3.2 degree (Wide-Tele)
Min. working distance	10 - 1500mm(Wide-Tele)	10 - 1000mm(Wide-Tele)
Aperture range	F1.6 - F5.0	F1.6 - F3.5
Pan/Tilt		
Pan / Tilt range	Pan: 360° endless; Tilt: -15° - 90° (Auto Flip)	
Pan / Tilt speed	Pan Manual Speed: 0.1° - 160°/s, Pan Preset Speed: 240°/s Tilt Manual Speed: 0.1° - 120°/s, Tilt Preset Speed: 200°/s	
Proportional zoom	Rotation speed can be adjusted automatically according to zoom multiples	
Number of preset	256	
Park action	Pattern/Pan scan/Tilt scan/Frame scan/Panorama scan/Random scan	
Patrol	8 patrols, up to 32 presets per patrol	
Power-off memory	Support	
PTZ position display	Support	
Preset freezing	Support	
Scheduled task	Preset / Patrol / Pattern / Pan scan / Tilt scan / Random scan / Frame scan / Panorama scan/Dome reboot/Self-test action/Alarm output	
Infrared		
IR distance	Up to 100m	
IR intensity	Automatically adjusted, depending on the zoom ratio	
Local Video/Audio		
Audio input	1 Mic in/Line in Interface, Line input: 2 - 2.4V(p-p); output Impedance: 1KΩ, ±10%	
Audio output	1 Audio output Interface, Line level, Impedance: 600Ω	
Network		
Ethernet	10Base-T / 100Base-TX, RJ45 connector	
Max. image resolution	1920x1080	
Frame rate	50Hz: 25 fps (1920x1080), 25 fps (1280x960), 25 fps (1280x720) 60Hz: 30 fps (1920x1080), 30 fps (1280x960), 30 fps (1280x720)	
Image compression	H.264/MJPEG	
Audio compression	G.711u/G.711a/G.726/MP2L2	
Protocols	IPv4/IPv6, HTTP, HTTPS, 802.1x, Qos, FTP, SMTP, UPnP, SNMP, DNS, DDNS, NTP, RTSP, RTP, TCP, UDP, IGMP, ICMP, DHCP, PPPoE	
Simultaneous five view	Up to 6	
Streams	Dual streams	
Mini SD memory card	Micro SD slot, up to 32GB	
User/Host level	Up to 32 users, 3 Levels: Administrator, Operator, User	
Security measures	User authentication (ID and PW), Host authentication (MAC address), IP address filtering	
Integration		
Application programming	Open-ended API, support Onvif, PSIA and CGI	
Web browser	IE 7+, Chrome 18+, Firefox 5.0+, Safari 5.02+	
General		
Power	-A: 24 VAC, max. 30W -AE: High-PoE & 24 VAC, max. 30W	
Working temperature	-30 °C - 65°C (-22°F - 149°F)	
Humidity	80% or less	
Protection level	IP66, TVS 4,000V lightning protection, surge protection and voltage transient protection	
Dimensions	Φ220x353.4mm (Φ8.66"x13.91") (Outdoor)	
Weight	Approx. 5.5kg(12.13lbs)	
Mount option	Long-arm wall mount: DS-1601ZJ; Corner mount: DS-1601ZJ-comer; Pole Mount: DS-1601ZJ-pole; Power box mount: DS-1634ZJ	